

PMA - PMA/C

direttamente accoppiato

Specifiche costruttive

Convogliatore a doppia flangia piana, provvisto di portino d'ispezione sulla cassa, realizzabile in quattro materiali: **acciaio al carbonio, acciaio INOX AISI 304 e AISI 316 e alluminio.**

Le rete antinfortunistica, lato motore e lato girante, è in acciaio al carbonio o acciaio INOX AISI 304 ed è costruita secondo le norme vigenti UNI EN 294.

Le giranti, ad alto rendimento con profilo alare e a falce, sono in materiale plastico (PPG, NYV, PAGAS), in acciaio al carbonio (Fe360) e in alluminio. L'equilibratura è eseguita secondo le norme vigenti UNI ISO 1940.

In esecuzione standard, il motore elettrico presenta protezione IP55, isolamento CL F, rendimento EFF2, servizio S1, tropicalizzati, tutti costruiti secondo le norme vigenti IEC/IEC (UNELMEC). Con i suddetti motori, sono disponibili le esecuzioni 4 e 5.

Construction specifications

*Round-shaped conveyor with inspection door on the case is feasible in **carbon steel, stainless steel AISI 304 and AISI 316 and aluminum.** Protection net, motor side and impeller side, is made of carbon steel or stainless steel AISI 304, it's built according to UNI 294 law. High efficiency and iron profile impellers are made of plastic (PPG, NYV, PAGAS), in carbon steel (Fe360) or aluminum. Balance's done according to UNI ISO 1940 regulation.*

During standard execution the electromotor has IP55 protection, CL F insulation, EFF2 efficiency, S1 service, tropicalized, each one built according to IEC/IEC (UNELMEC) laws. Executions 4 and 5 are available with motors above said.

PMA

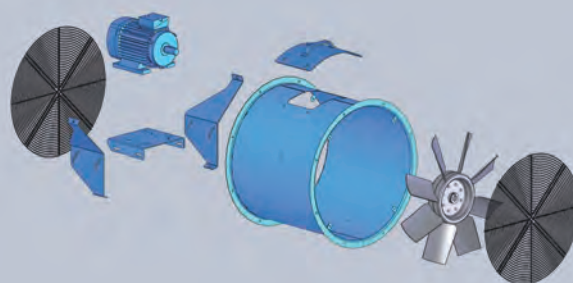

PMA/C

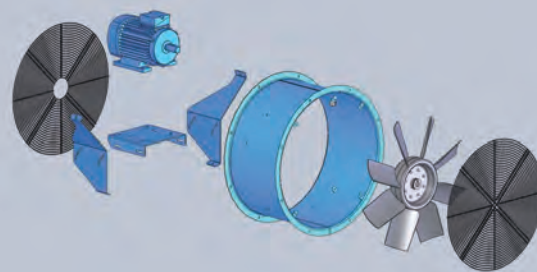

PMA - DFP
interamente intubato

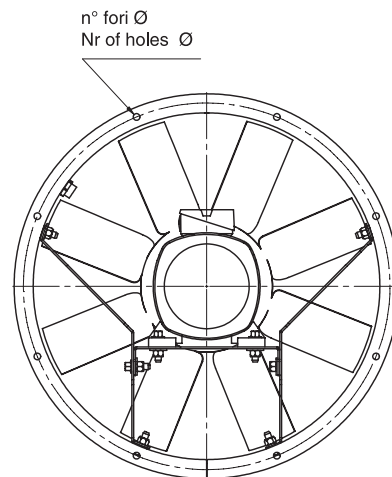
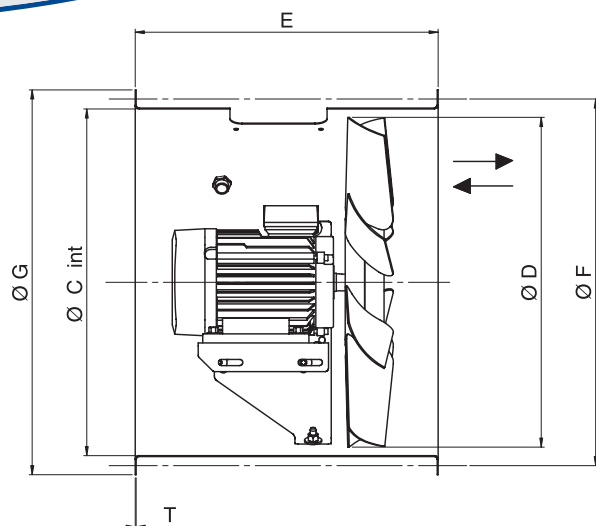

Modello Type	Motore Motor	Dimensioni Dimensions						Fori Holes		Peso Weight kg
		C	D	E	F	G	T	n°	Ø	
310	63	315	305	300	348	378	1,5	6	11	9
	71	315	305	300	348	378	1,5	6	11	13
350	63	360	350	300	400	423	1,5	6	11	11
	80	360	350	300	400	423	1,5	6	11	15
400	63	410	400	300	448	473	1,5	6	11	15
	71	410	400	300	448	473	1,5	6	11	18
	80	410	400	300	448	473	1,5	6	11	21
450	100	410	400	300	448	473	1,5	6	11	32
	71	460	450	400	495	523	1,5	6	11	20
	80	460	450	400	495	523	1,5	6	11	25
500	100	460	450	400	495	523	1,5	6	11	36
	71	510	500	450	545	573	1,5	8	11	28
	80	510	500	450	545	573	1,5	8	11	34
560	132	510	500	450	545	573	1,5	8	11	70
	71	570	560	500	605	633	1,5	8	11	33
	80	570	560	500	605	633	1,5	8	11	35
	90	570	560	500	605	633	1,5	8	11	35
630	132	570	560	500	605	633	1,5	8	11	70
	80	640	630	500	675	704	2	8	11	40
	90	640	630	500	675	704	2	8	11	50
	100	640	630	500	675	704	2	8	11	58
710	132	640	630	500	675	704	2	8	11	90
	90	710	700	500	745	774	2	12	14	65
	100	710	700	500	745	774	2	12	14	71
	112	710	700	500	745	774	2	12	14	75
800	132	710	700	500	745	774	2	12	14	103
	90	810	800	560	855	884	2	12	14	75
	100	810	800	560	855	884	2	12	14	90
	112	810	800	560	855	884	2	12	14	55
900	132	810	800	560	855	884	2	12	14	106
	100	910	900	650	955	1004	3	16	14	110
	112	910	900	650	955	1004	3	16	14	130
1000	132	910	900	650	955	1004	3	16	14	180
	100	1010	1000	650	1070	1104	3	16	14	130
	112	1010	1000	650	1070	1104	3	16	14	140
	132	1010	1000	650	1070	1104	3	16	14	180
1120	160	1010	1000	650	1070	1104	3	16	14	210
	132	1130	1110	900	1185	1240	3	20	16	185
	160	1130	1110	900	1185	1240	3	20	16	245
1250	180	1130	1110	900	1185	1240	3	20	16	310
	160	1260	1238	1000	1320	1370	3	20	16	210
	180	1260	1238	1000	1320	1370	3	20	16	280
1400	180	1410	1380	1120	1465	1520	3	20	16	425
	200	1410	1380	1120	1465	1520	3	20	16	485
	250	1410	1380	1120	1465	1520	3	20	16	500

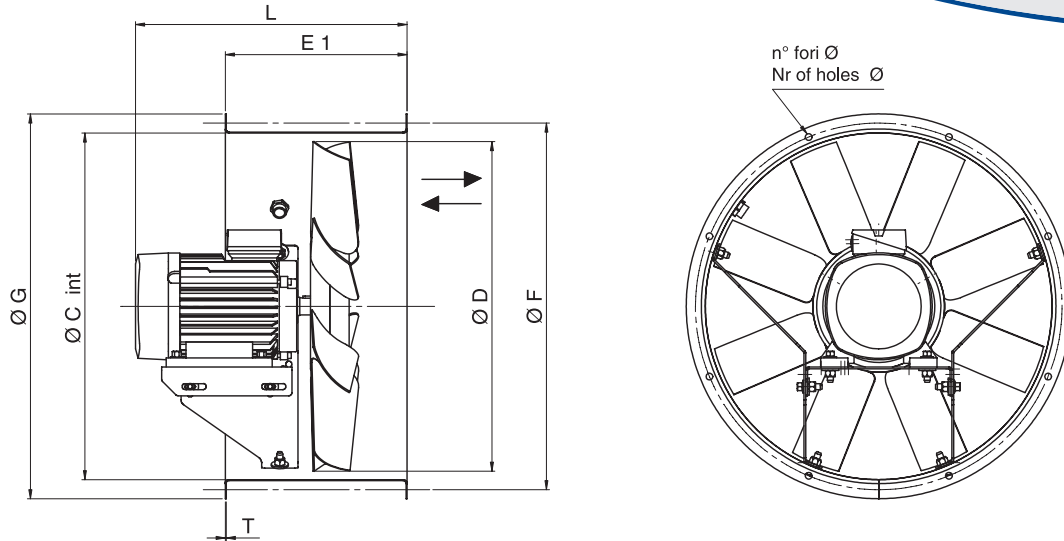

Modello Type	Motore Motor	Dimensioni Dimensions							Fori Holes		Peso Weight kg
		C	D	E1	F	G	L	T	n°	Ø	
310	63	315	305	200	348	378	295	1,5	6	11	7
	71	315	305	200	348	378	330	1,5	6	11	11
350	63	360	350	215	400	423	295	1,5	6	11	7,5
	80	360	350	215	400	423	400	1,5	6	11	11,5
400	63	410	400	215	448	473	315	1,5	6	11	11
	71	410	400	215	448	473	330	1,5	6	11	13
	80	410	400	215	448	473	410	1,5	6	11	17,5
450	100	410	400	215	448	473	465	1,5	6	11	28
	71	460	450	230	495	523	330	1,5	6	11	14
	80	460	450	230	495	523	410	1,5	6	11	19
500	100	460	450	230	495	523	470	1,5	6	11	30
	71	510	500	270	545	573	350	1,5	8	11	22
	80	510	500	270	545	573	410	1,5	8	11	24
560	132	510	500	270	545	573	590	1,5	8	11	60
	71	570	560	300	605	633	360	1,5	8	11	23
	80	570	560	300	605	633	420	1,5	8	11	25
	90	570	560	300	605	633	450	1,5	8	11	25
630	132	570	560	300	605	633	610	1,5	8	11	65
	80	640	630	300	675	704	420	2	8	11	26
	90	640	630	300	675	704	450	2	8	11	39
	100	640	630	300	675	704	510	2	8	11	44
710	132	640	630	300	675	704	640	2	8	11	80
	90	710	700	300	745	774	450	2	12	14	48
	100	710	700	300	745	774	510	2	12	14	55
	112	710	700	300	745	774	530	2	12	14	60
800	132	710	700	300	745	774	630	2	12	14	83
	90	810	800	350	855	884	470	2	12	14	55
	100	810	800	350	855	884	510	2	12	14	60
	112	810	800	350	855	884	540	2	12	14	70
900	132	810	800	350	855	884	640	2	12	14	84
	100	910	900	500	955	1004	530	3	16	14	80
	112	910	900	500	955	1004	560	3	16	14	100
	132	910	900	500	955	1004	680	3	16	14	150
1000	100	1010	1000	500	1070	1104	530	3	16	14	100
	112	1010	1000	500	1070	1104	560	3	16	14	135
	132	1010	1000	500	1070	1104	680	3	16	14	165
	160	1010	1000	500	1070	1104	780	3	16	14	180
1120	132	1130	1110	550	1185	1240	680	3	20	16	135
	160	1130	1110	550	1185	1240	830	3	20	16	185
	180	1130	1110	550	1185	1240	880	3	20	16	270
1250	160	1260	1238	550	1320	1370	830	3	20	16	130
	180	1260	1238	550	1320	1370	880	3	20	16	220
1400	180	1410	1380	550	1465	1520	880	3	20	16	345
	200	1410	1380	550	1465	1520	980	3	20	16	395
	250	1410	1380	550	1465	1520	1130	3	20	16	450

Modello Type	Motore Motor			dB(A)	Portata Airflow m3/h										Pressione statica Static pressure HS [Pa]	
	rpm	kW	Size		10	50	100	150	200	300	400	500	600	700		800
312A	2800	0,55	71	71	4400	4250	4000	3750	3350	2700						
314A	1400	0,12	63	58	2700	2000										
352A	2800	1,1	80	74	5750	5600	5440	5250	5000	4500	3740					
354A	1400	0,12	63	60	3100	2600										
402A	2800	1,1	80	75	7320	7200	7000	6750	6540	6000	5300	4100				
402B	2800	2,2	90	82	9950	9780	9500	9150	8800	8140	7500	6200				
404A	1400	0,25	71	64	4900	4300	3600									
404B	1400	0,37	71	63	6100	5280	4500									
406A	900	0,12	63	58	3800											
452A	2900	3	100	82	13500	13000	12700	12250	11800	10750	9600	8150				
454A	1400	0,37	71	64	6700	6150	5300									
454B	1400	0,55	80	69	8350	7550	6600									
456A	900	0,18	71	61	5300	4100										
502A	2900	4	112	86	16300	16000	15800	15100	14650	14000	13000	11700	10000	7500		
504A	1400	0,55	80	69	9400	8300	7000									
504B	1400	0,75	80	71	10000	9200	8140	6800								
506A	900	0,25	71	62	7200	5750										
562A	2900	5,5	132	84	22000	21500	21000	20400	20000	18800	17800	16400	15000	13000	10000	
564A	1400	0,75	80	64	11400	10400	9450	7800								
564B	1400	1,1	90	69	14500	13400	12100	10700								
566A	900	0,37	80	60	9900	8200										
568A	700	0,18	80	60	7250	5250										
632A	2900	7,5	132	89	28100	27500	27000	26200	26000	24800	23000	21400	20000	17600	15100	
634A	1400	1,1	90	69	16300	15000	13000	10400	5100							
634B	1400	1,5	90	74	17000	16000	14800	13000	10400							
634C	1400	2,2	100	76	18700	17800	16600	15300	13600							
636A	900	0,37	80	64	10200	9000	6000									
636B	900	0,75	90	69	12600	11200	8800									
638A	700	0,18	80	58	9000	6100										
714A	1400	2,2	100	75	25100	23700	22300	20000	17700							
714B	1400	3	100	79	26500	25100	23700	22600	21300	16300						
714C	1400	4	112	83	30500	29100	28000	27100	25000	20000						
716A	900	0,75	90	69	16300	14000	10000									
716B	900	1,1	90	73	19900	17800	15000									
718A	700	0,37	90	65	12900	9600										
804A	1400	3	100	79	29100	27800	27000	25000	23200	19000	12400					
804B	1400	4	112	81	33800	32500	31300	30000	27800	22800	13600					
804C	1400	5,5	132	84	38200	37200	36000	34000	32600	28200	23300					
804D	1400	7,5	132		43100	42000	40000	38600	37500	32500	26000					
806A	900	1,1	90	68	21500	18800	16200	8300								
806B	900	1,5	100	72	24400	22500	20000	16200								
808A	700	0,55	90	64	17500	14400										
808B	700	0,75	100	67	21100	17600										

Modello Type	Motore Motor			dB(A)	Portata Airflow m3/h										Pressione statica Static pressure HS [Pa]	
	rpm	kW	Size		10	50	100	150	200	300	400	500	600	700		800
	904A	1400	4		112	83	39700	37500	36200	34000	32200	26100	17500	12500		
904B	1400	5,5	132	83	45000	44000	42400	40000	37500	32200	22000	16300				
904C	1400	11	160	86	52000	51300	50000	48800	47500	44000	39000	32500	25000			
906A	900	1,1	90	74	25400	22500	19000	12500	7800							
906B	900	2,2	112	73	31000	28000	27000	24000	18800							
906C	900	4	132	79	37800	35000	32500	30000	25000							
908A	700	0,75	100	66	23000	18800	11000									
908B	700	1,1	100	69	25100	22500	17500									
1004A	1400	5,5	132	81	45500	44200	42500	41000	37800	32500	23000	16600	11300			
1004B	1400	7,5	132	84	54100	52300	50000	47800	42600	40000	30000	21000	15000			
1004C	1400	11	160	86	63200	61000	60000	58300	56000	51800	46000	35000	25000			
1006A	900	2,2	112	75	38300	35000	31400	26300	16200							
1006B	900	3	132	76	43000	40000	36200	31200	20000							
1006C	900	5,5	132	80	49300	47500	45000	41200	37000							
1008A	700	1,1	100	72	30000	26000	18800									
1008B	700	2,2	132	74	36300	32500	27300									
1124A	1400	11	160	86	63600	62000	60000	58700	57000	53000	50000	45000	36200	27500		
1124B	1400	15	160	90	77600	75000	73300	72000	70000	65200	61000	55500	50000	37500		
1124C	1400	22	180	91	90000	88500	87000	84300	83000	78000	75000	67800	61000	45000		
1126A	900	3	132	77	44800	42300	38100	35000	31000	15000						
1126B	900	4	132	80	47700	45000	42600	39800	35000	21000						
1126C	900	5,5	132	82	56100	53800	50000	47200	42600	27100						
1128A	700	2,2	132	76	39100	36000	32000	25000								
1128B	700	4	160	78	54400	50000	43400	35000								
1256A	700	5,5	132	81	63800	60000	55300	51500	46700	32500						
1256B	700	7,5	160	83	74000	70000	65000	61000	51000	42500						
1256C	700	11	160	86	80900	78000	75000	70000	65000	56100						
1258A	700	4	160	78	60300	55000	48800	40000								
1258B	700	5,5	160	76	68700	62000	55000	40000								
1406A	900	15	180	88	108000	105000	100000	96000	91000	80000	64000					
1406B	900	22	200	90	120000	115000	110000	106000	100000	90000	70000					
1406C	900	37	250	91	147000	144000	141000	138000	135000	128000	120000					
1408A	700	5,5	160	82	75500	70000	65000	58000	50000							
1408B	700	7,5	160	83	89000	83000	76000	70000	60000							
1408C	700	11	180	85	100000	94000	86000	78000	52000							

Esecuzioni su richiesta
con pressioni fino a 2000 Pa

Competenza a tutto campo

The utmost competence

La **Pressione Totale** di un ventilatore è divisa in due parti: la **pressione dinamica**, che rappresenta la misura dell'energia cinetica all'uscita del ventilatore, la **pressione statica**, che rappresenta il lavoro svolto in compressione e pienamente disponibile, mentre solo una parte della pressione dinamica può essere utilizzata a causa delle perdite per conversione.

In caso di funzionamento del ventilatore a **bocca libera** la pressione statica sarà nulla corrispondente al punto finale della curva di prestazione con portata massima, condizione per cui:

$$P_t = P_d$$

In caso di funzionamento a **bocca chiusa** la pressione dinamica sarà nulla, condizione per cui:

$$P_t = P_s$$

La **Portata Volumica** di un fluido è il volume del fluido che passa nell'unità di tempo attraverso il ventilatore, sintetizzata dalla seguente formula:

$$Q = v \times A \times 3600 \text{ [m}^3\text{/h]}$$

dove:

v = velocità fluido [m/s]

A = area sezione condotto [m²]

La **Potenza Assorbita** rappresenta la misurazione effettuata all'asse della girante e sintetizzata dalla seguente formula:

$$\text{Pass.} = \frac{Q \times P_t \times 100}{E_f\%}$$

dove:

Q = Portata Volumica [m³/s]

P_t = Pressione Totale [Pa]

E_f = Efficienza Totale

Aria in Condizioni Standard:

Densità = 1.225 [kg/m³]

Temperatura = 15°C

P_{atm} = 1013 mBar al livello del mare

The fan Total Pressure is divided in two parts: the dynamic pressure, which is a measure of the kinetic energy at the fan outlet, the static pressure, which represents the work done in compression and fully available at the user, whereas only part of dynamic pressure can be utilized due to conversion losses.

In case of **free mouth** operation the static pressure will equal zero corresponding to the end point of the performance curve with maximum airflow, by this condition:

$$P_t = P_d$$

In case of **closed mouth** the dynamic pressure will equal zero, by this condition:

$$P_t = P_s$$

The **Volume Flow** of a fluid is the fluid volume which passes through the fan in the time unit, by this condition:

$$Q = v \times A \times 3600 \text{ [m}^3\text{/h]}$$

where:

v = fluid speed [m/s]

A = duct section area [m²]

The **Power Absorbed** represents the measurement made to the axis of the impeller, by this condition:

$$\text{Pass.} = \frac{Q \times P_t \times 100}{E_f\%}$$

where:

Q = Volume Flow [m³/s]

P_t = Total Pressure [Pa]

E_f = Total Efficiency

Air Standard Condition is defined as:

Density = 1.225 [kg/m³]

Temperature = 15°C

P_{atm} = 1013 mBar at sea level

esempio di lettura reading example

• Pressione statica *Static pressure*
H_{st} = 400 Pa

• Portata aria *Airflow*
Q = 80000 m³/h

• Potenza assorbita *Absorbed power*
P = 20 kW



mod. 312/A · 0,55 kW Potenza installata Motor power

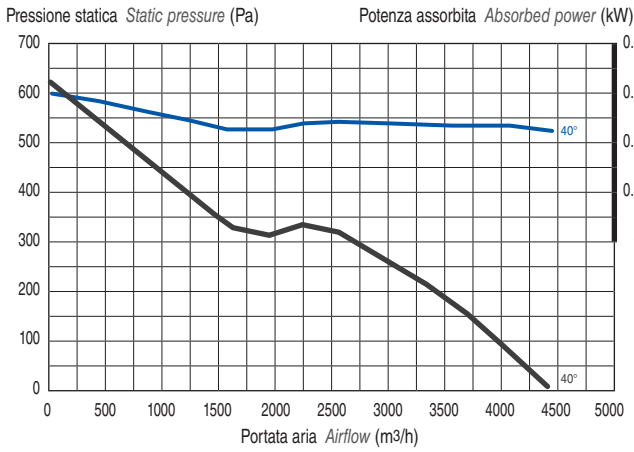

mod. 452/A · 3 kW Potenza installata Motor power

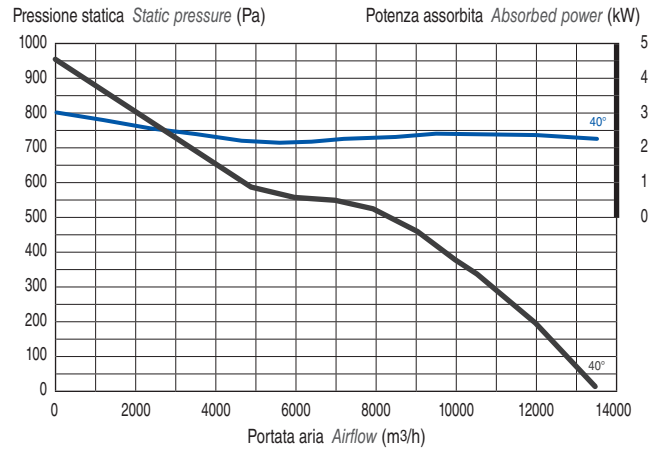

mod. 352/A · 1,1 kW Potenza installata Motor power

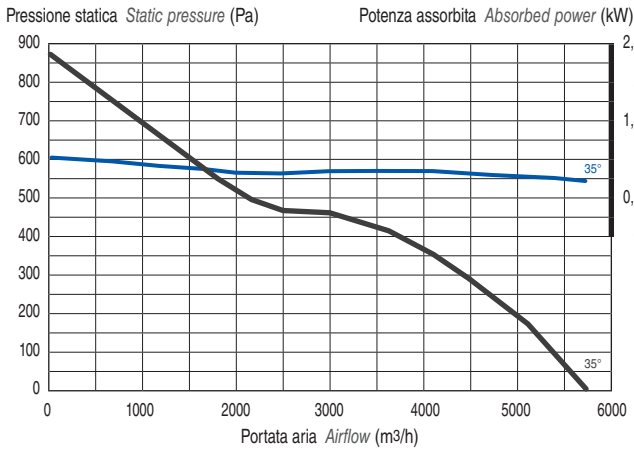

mod. 502/A · 4 kW Potenza installata Motor power

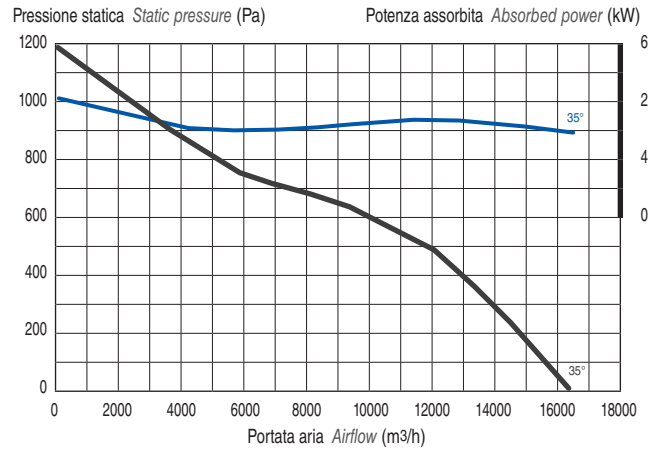

mod. 402/A · 1,1 kW Potenza installata Motor power

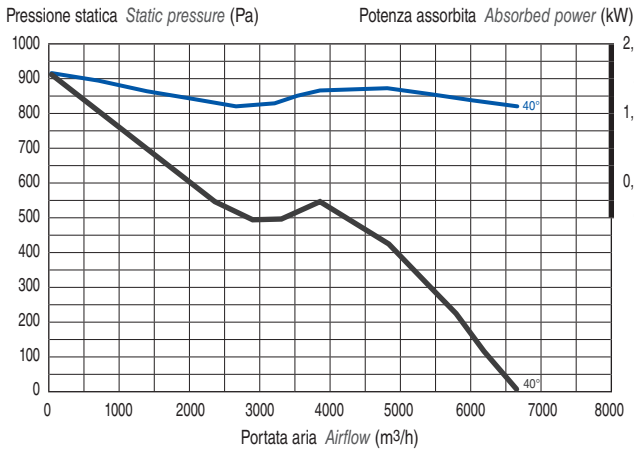

mod. 562/A · 5,5 kW Potenza installata Motor power

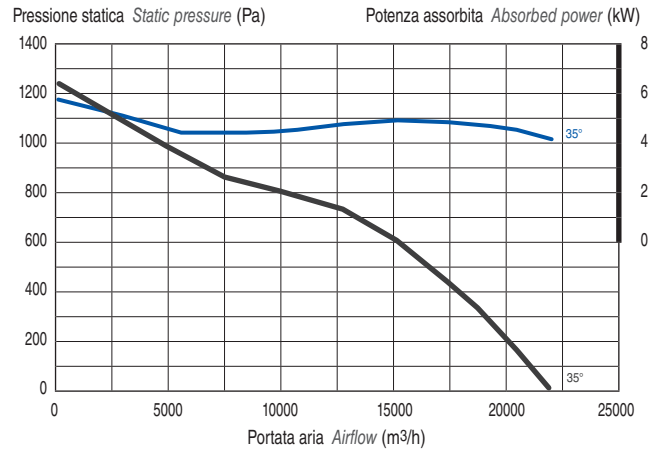

mod. 402/B · 2,2 kW Potenza installata Motor power

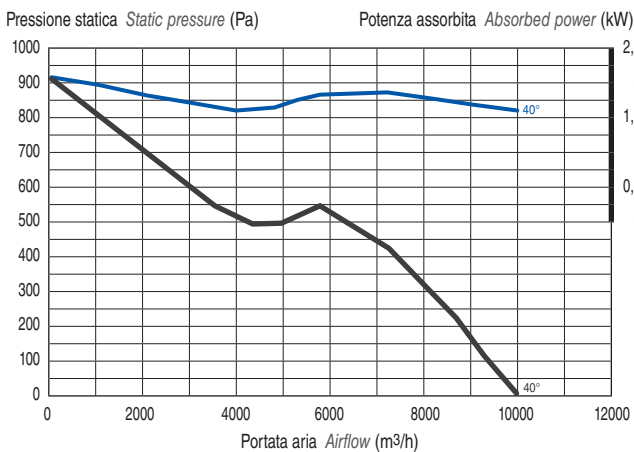

mod. 632/A · 7,5 kW Potenza installata Motor power

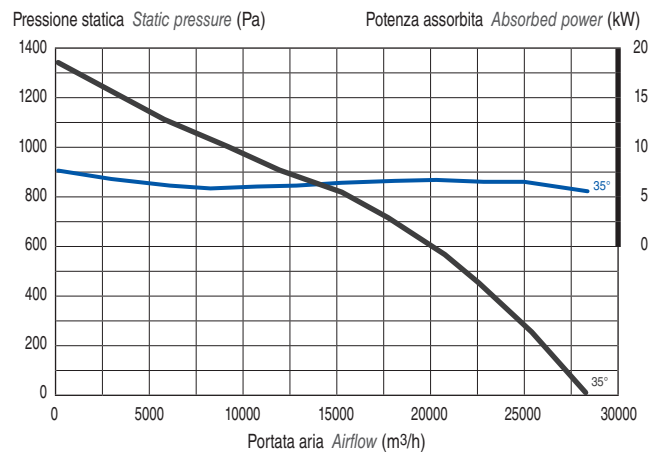

mod. 314/A · 0,12 kW Potenza installata Motor power

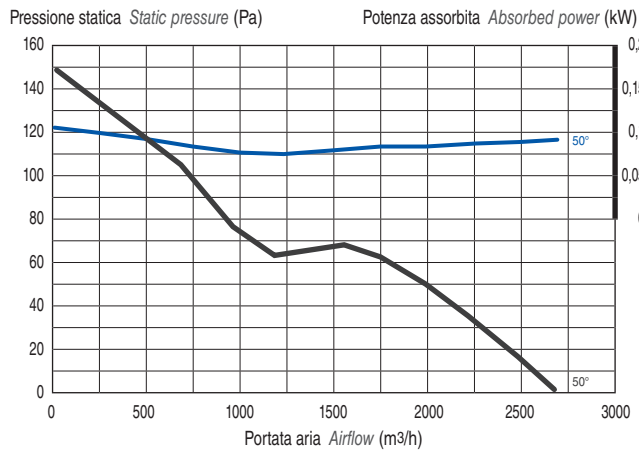

mod. 404/B · 0,37 kW Potenza installata Motor power

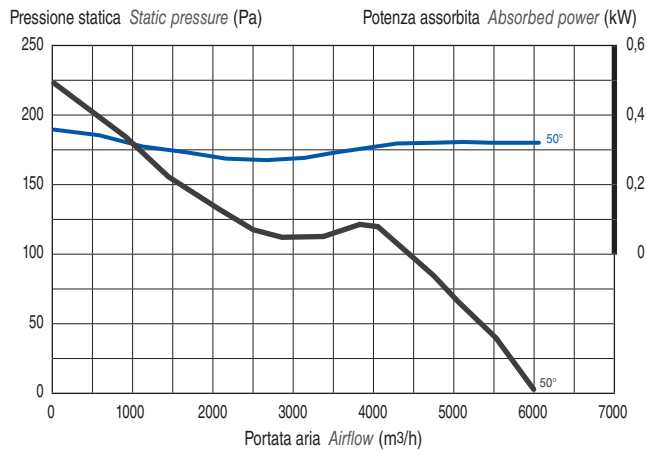

mod. 354/A · 0,12 kW Potenza installata Motor power

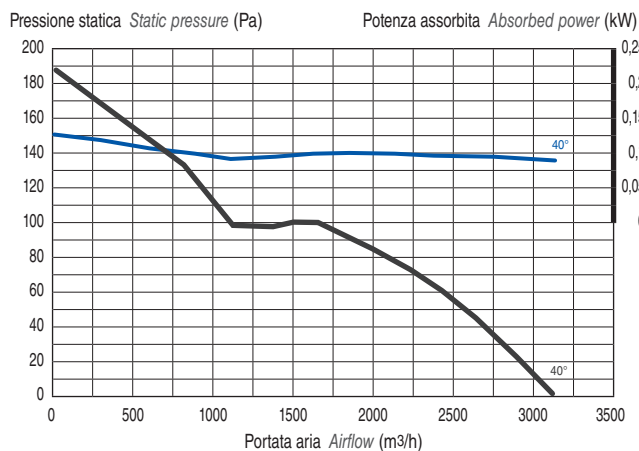

mod. 454/A · 0,37 kW Potenza installata Motor power

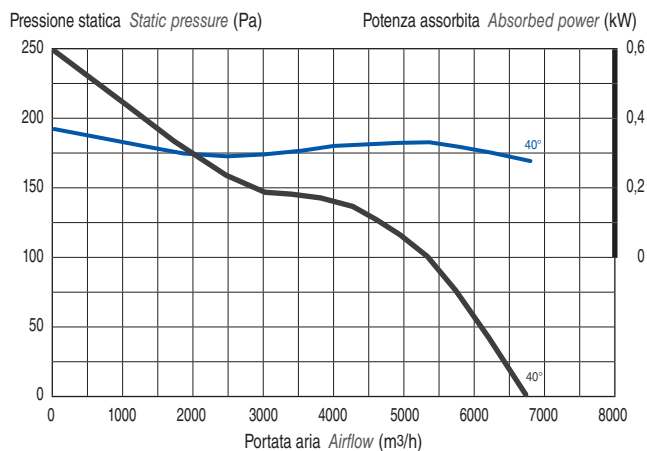

mod. 354/B · 0,00 kW Potenza installata Motor power

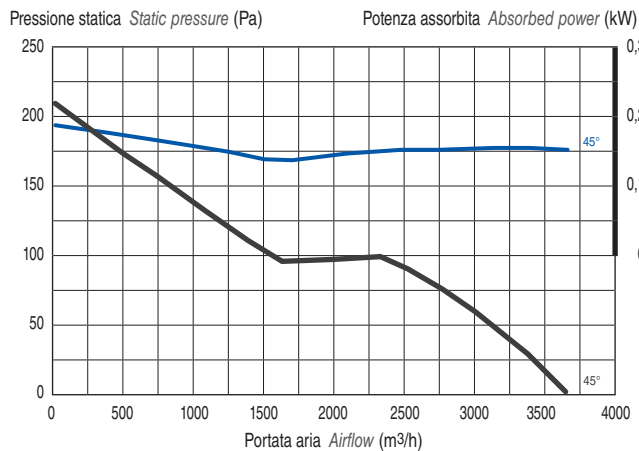

mod. 454/B · 0,55 kW Potenza installata Motor power

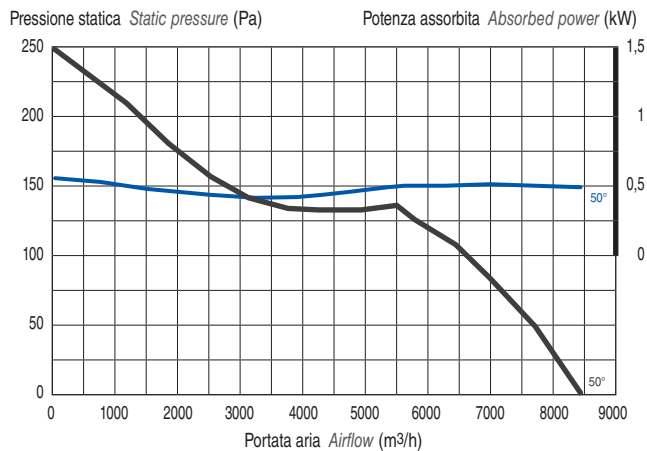

mod. 404/A · 0,25 kW Potenza installata Motor power

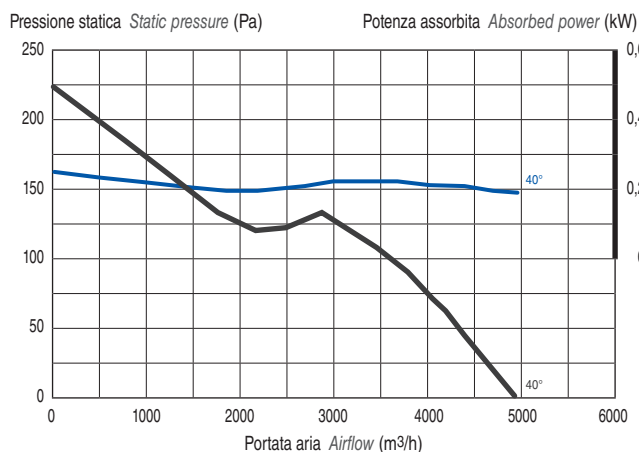

mod. 504/A · 0,55 kW Potenza installata Motor power

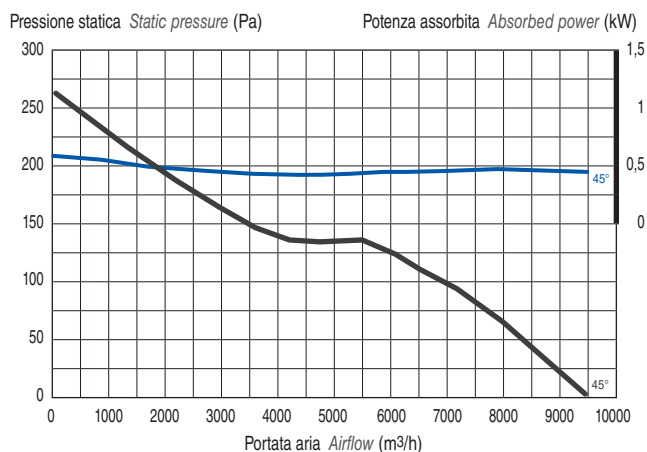

mod. 504/B · 0,75 kW Potenza installata Motor power

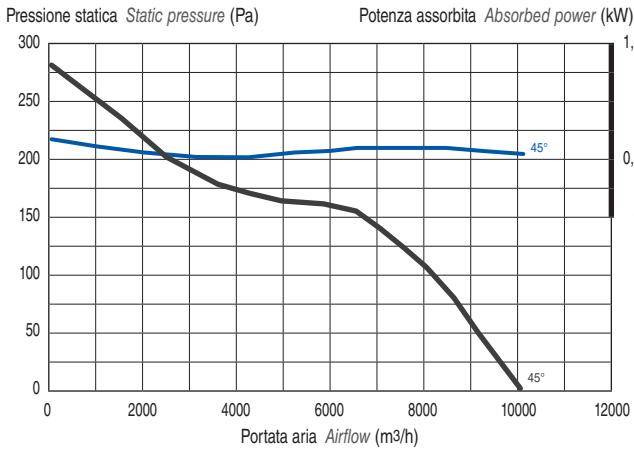

mod. 634/B · 1,5 kW Potenza installata Motor power

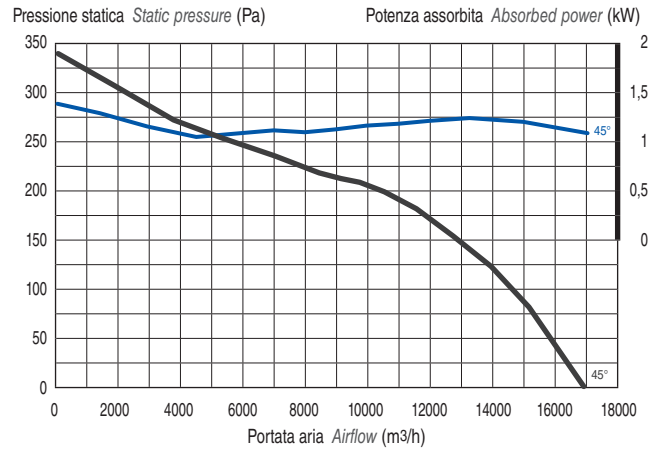

mod. 564/A · 0,75 kW Potenza installata Motor power

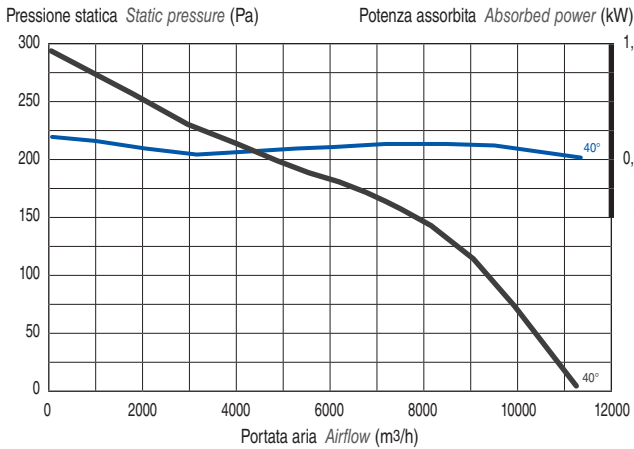

mod. 634/C · 2,2 kW Potenza installata Motor power

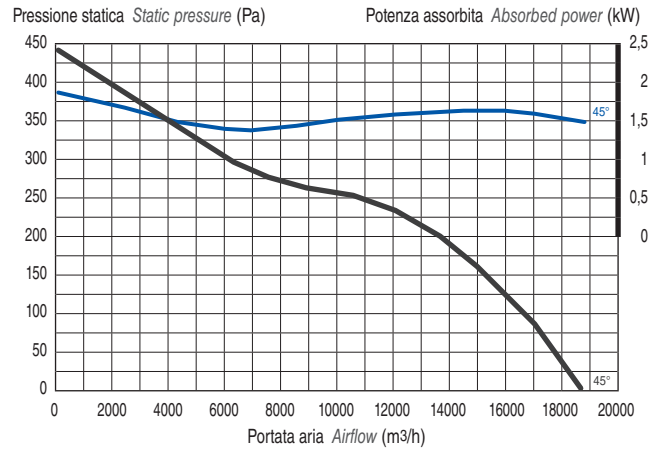

mod. 564/B · 1,1 kW Potenza installata Motor power

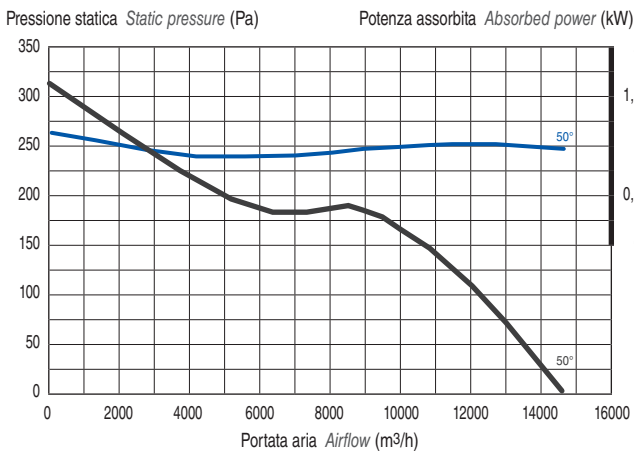

mod. 714/A · 2,2 kW Potenza installata Motor power

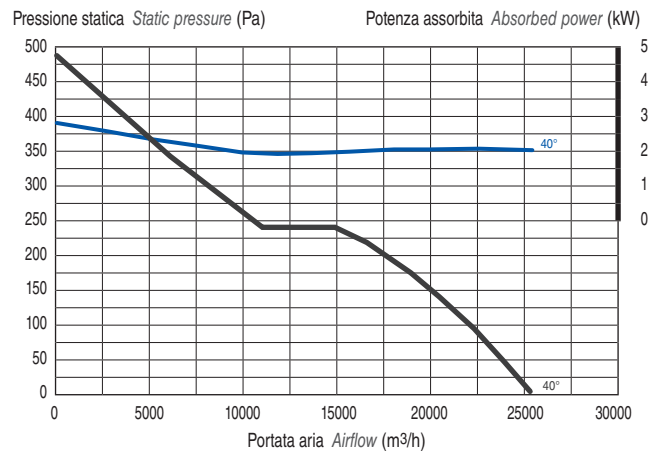

mod. 634/A · 1,1 kW Potenza installata Motor power

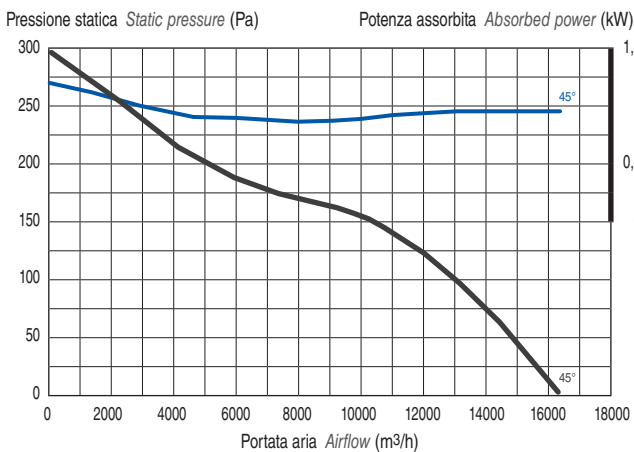

mod. 714/B · 3 kW Potenza installata Motor power

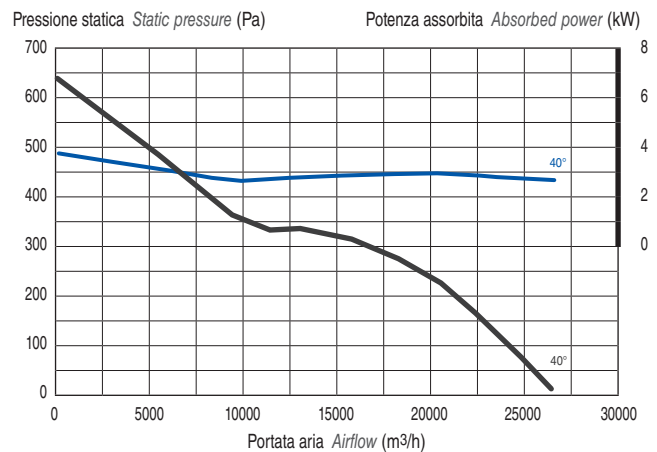

mod. 804/A · 3 kW Potenza installata Motor power

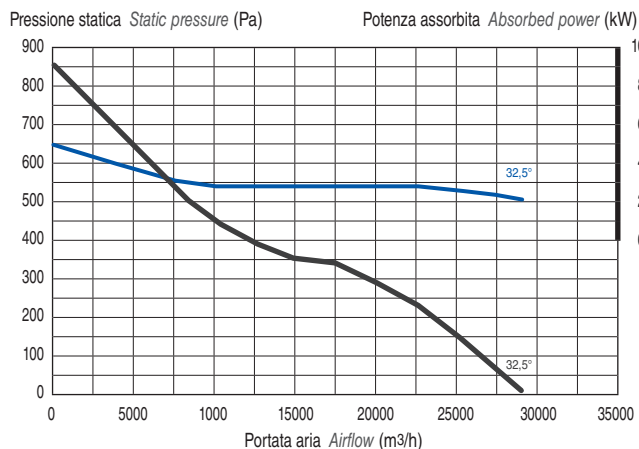

mod. 904/A · 4 kW Potenza installata Motor power

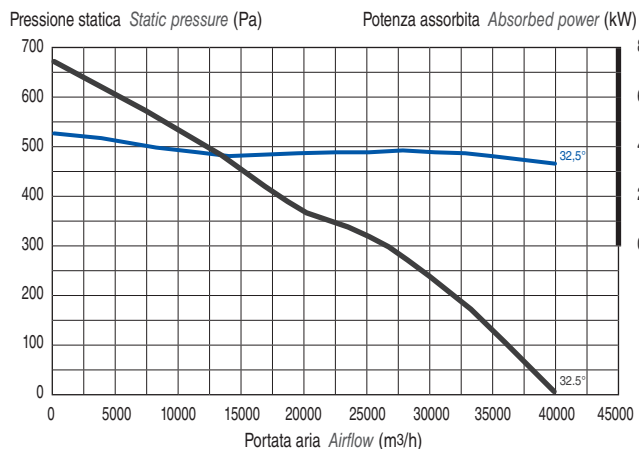

mod. 804/B · 4 kW Potenza installata Motor power

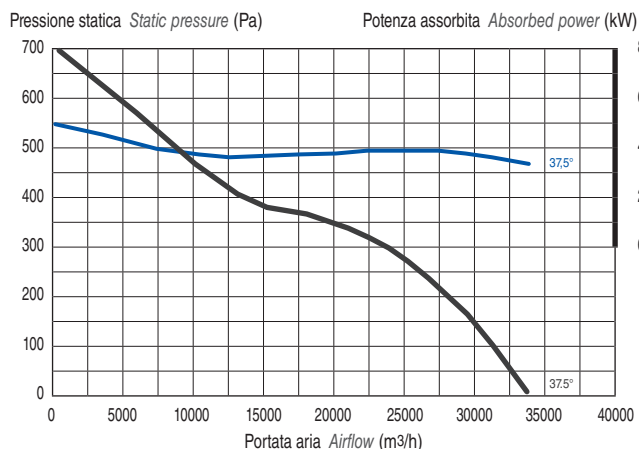

mod. 904/B · 5,5 kW Potenza installata Motor power

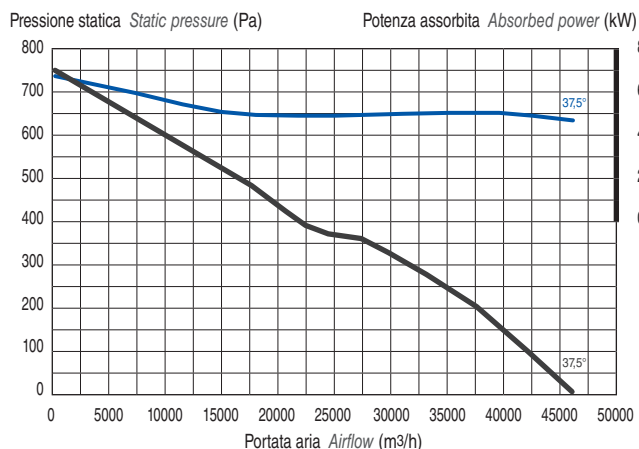

mod. 804/C · 5,5 kW Potenza installata Motor power

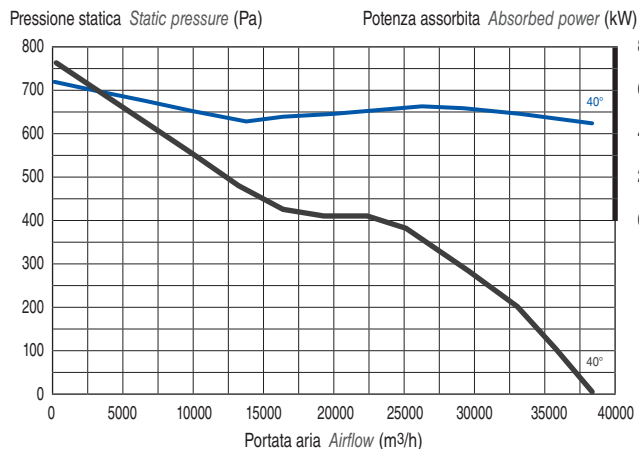

mod. 904/C · 11 kW Potenza installata Motor power

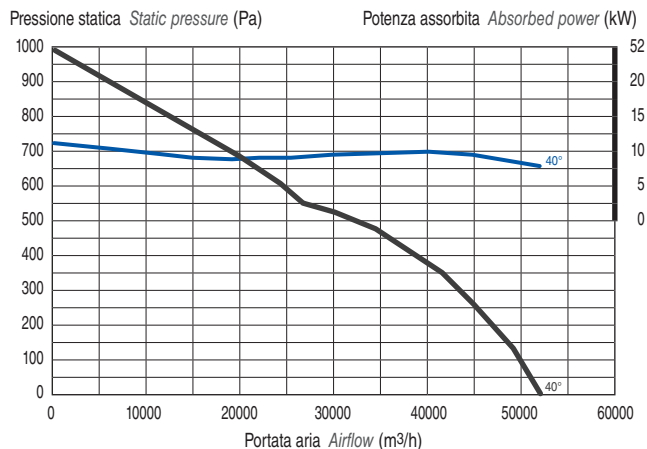

mod. 804/D · 7,5 kW Potenza installata Motor power

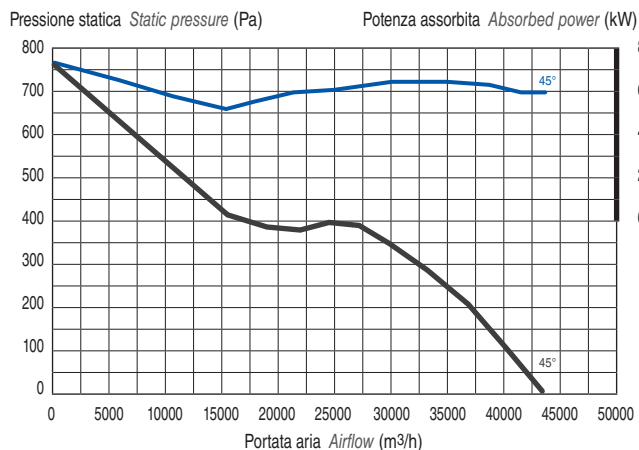

mod. 1004/A · 5,5 kW Potenza installata Motor power

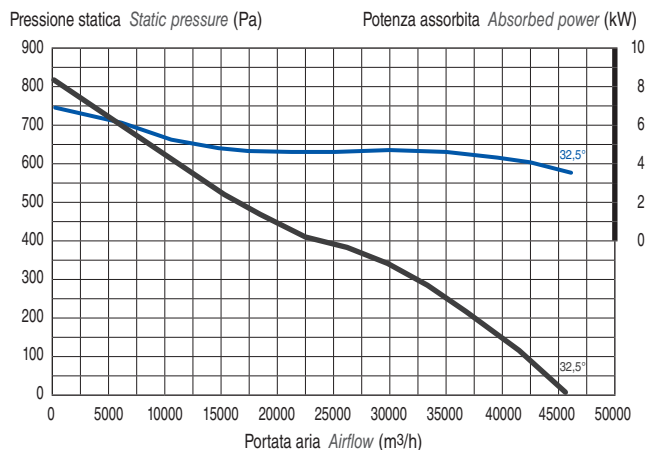

mod. 1004/B · 7,5 kW Potenza installata Motor power

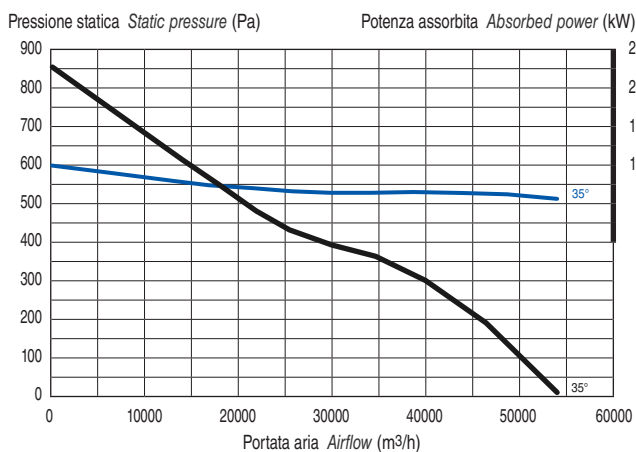

mod. 1124/B · 15 kW Potenza installata Motor power

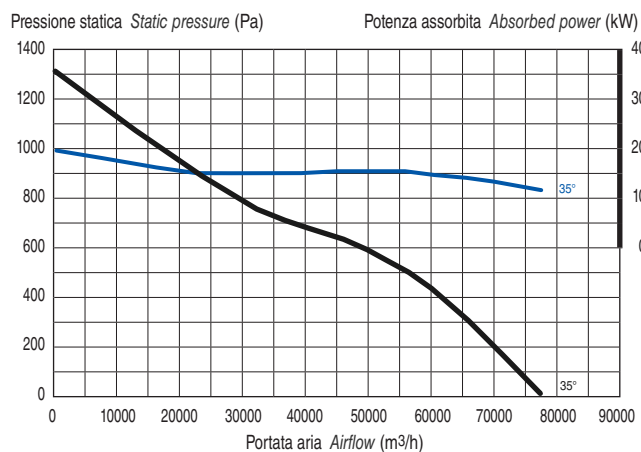

mod. 1004/C · 11 kW Potenza installata Motor power

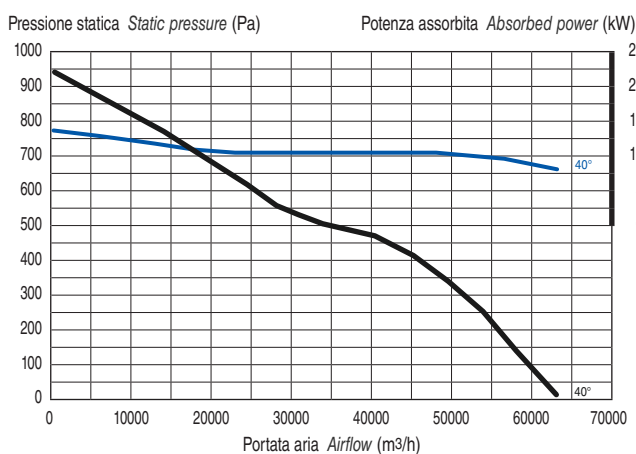

mod. 1124/C · 22 kW Potenza installata Motor power

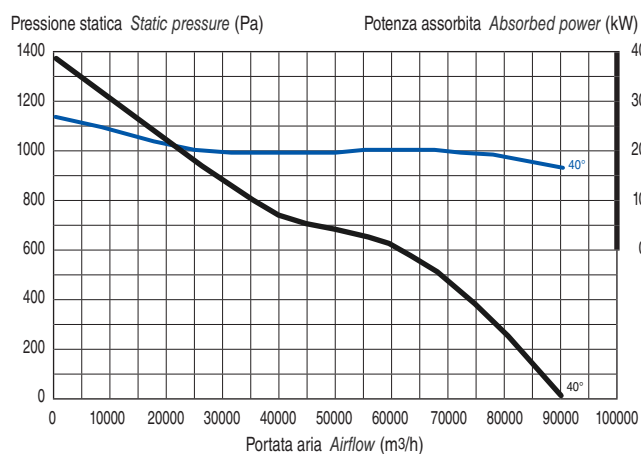

mod. 1124/A · 11 kW Potenza installata Motor power

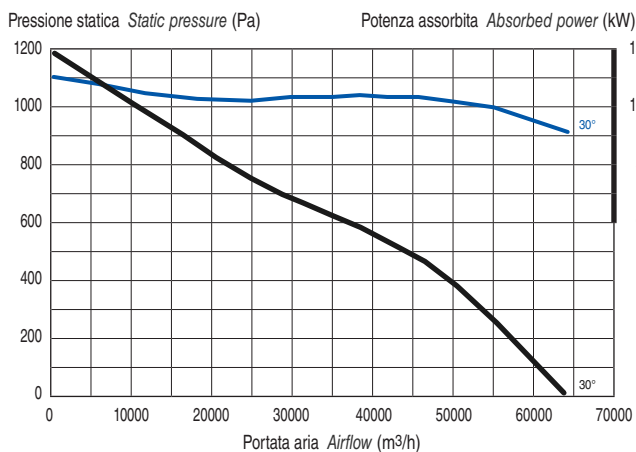

mod. 406/A · 0,12 kW Potenza installata Motor power

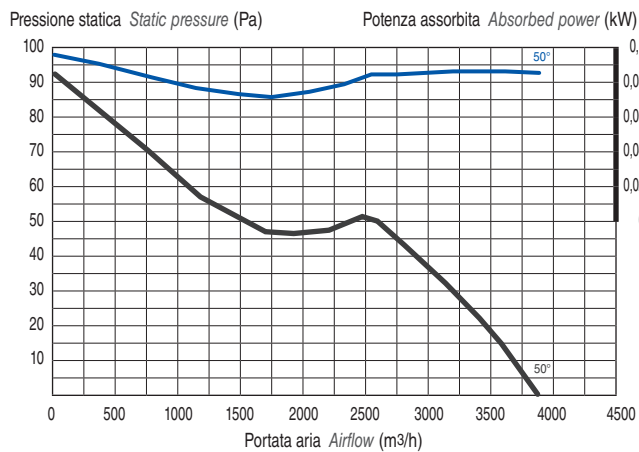

mod. 636/A · 0,37 kW Potenza installata Motor power

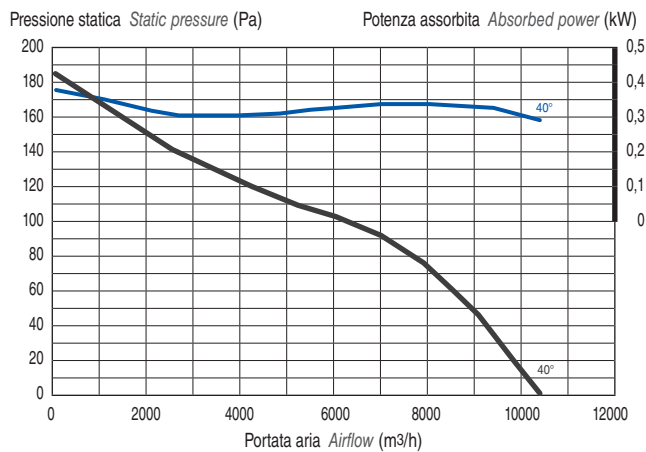

mod. 456/A · 0,18 kW Potenza installata Motor power

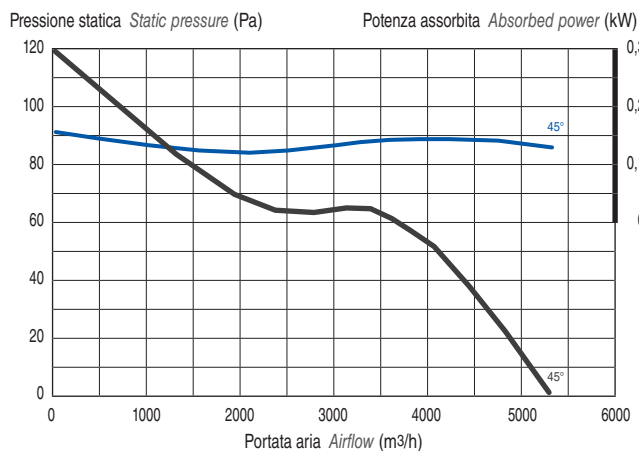

mod. 636/B · 0,75 kW Potenza installata Motor power

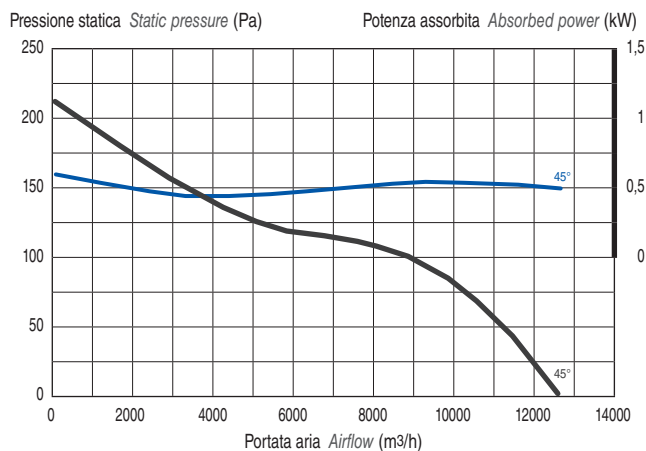

mod. 506/A · 0,25 kW Potenza installata Motor power

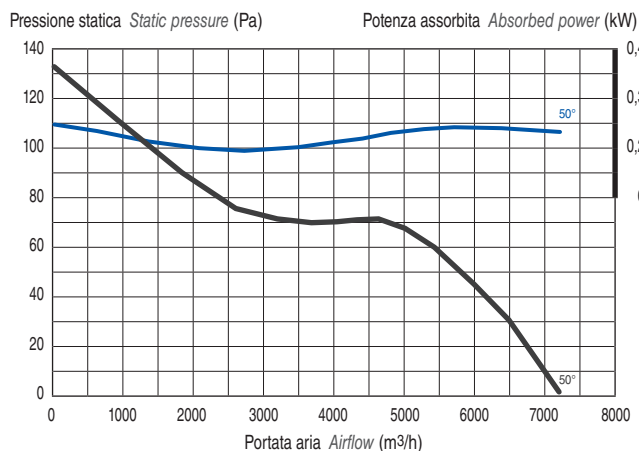

mod. 716/A · 0,75 kW Potenza installata Motor power

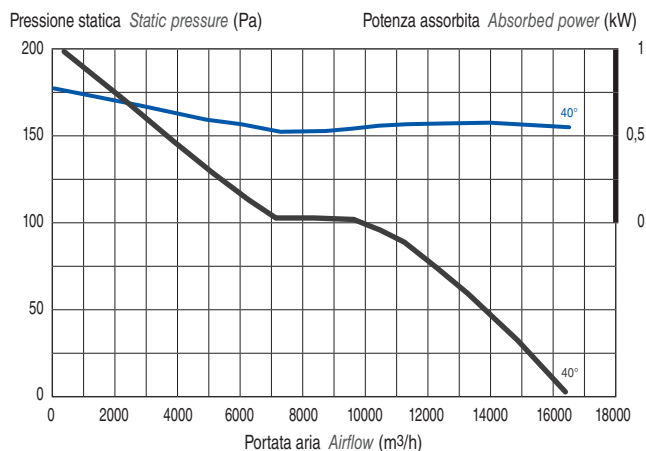

mod. 566/A · 0,37 kW Potenza installata Motor power

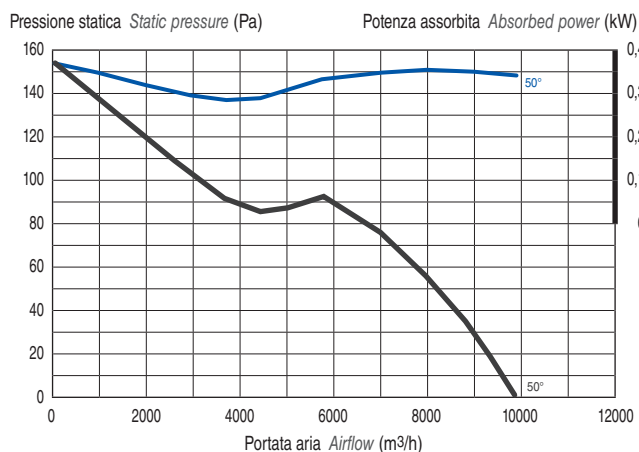

mod. 716/B · 1,1 kW Potenza installata Motor power

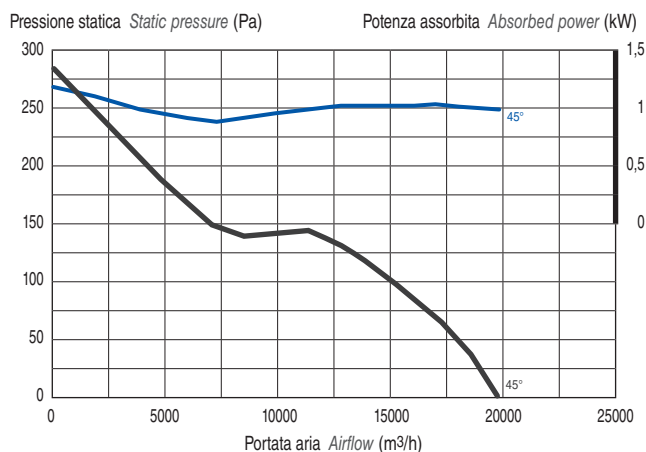

mod. 806/A · 1,1 kW Potenza intallata Motor power

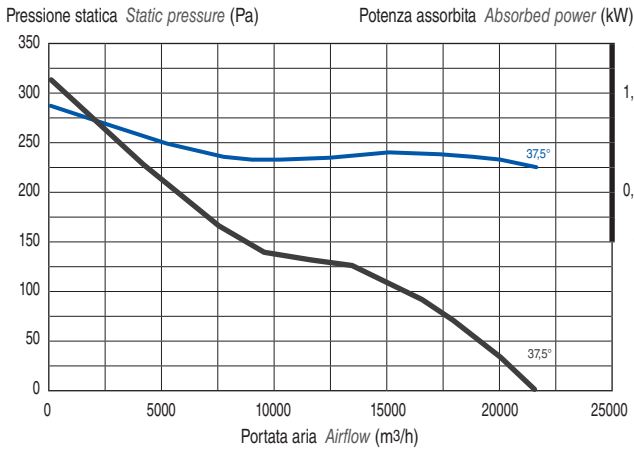

mod. 906/C · 4 kW Potenza intallata Motor power

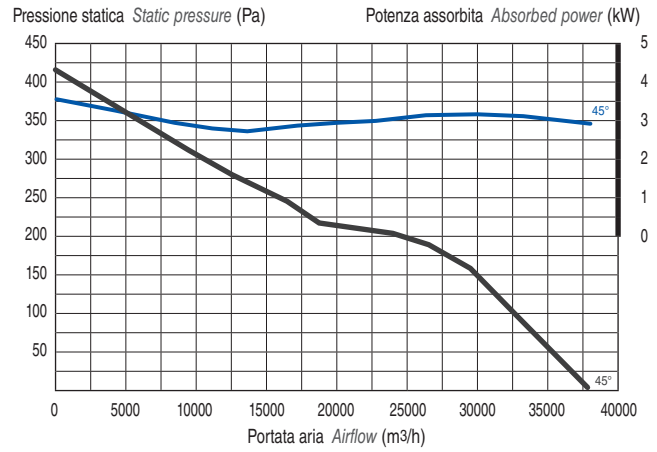

mod. 806/B · 1,5 kW Potenza intallata Motor power

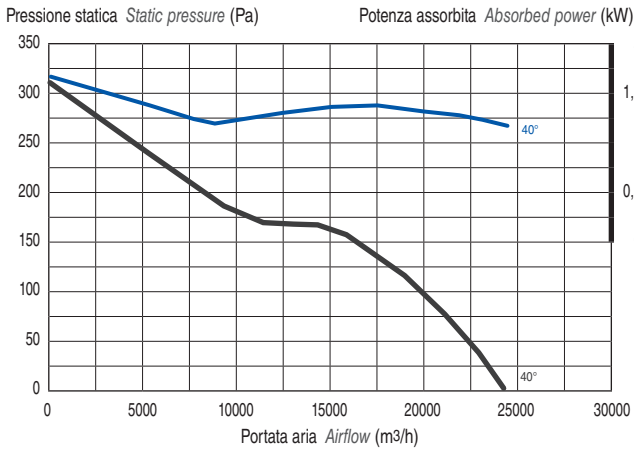

mod. 1006/A · 2,2 kW Potenza intallata Motor power

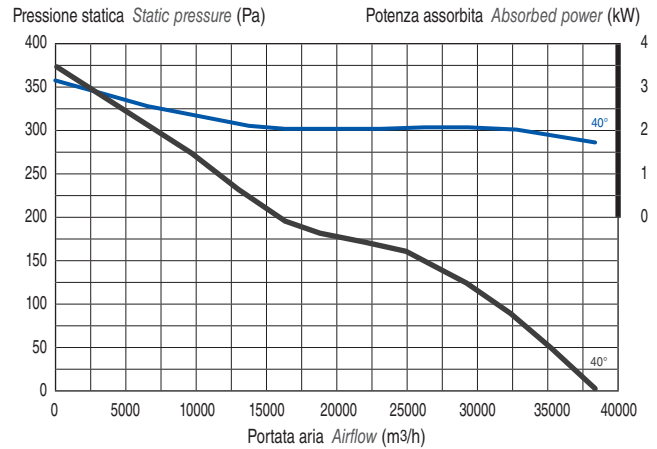

mod. 906/A · 1,1 kW Potenza intallata Motor power

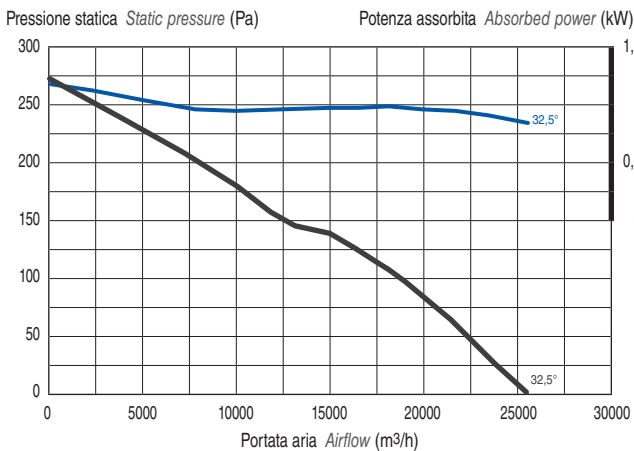

mod. 1006/B · 3 kW Potenza intallata Motor power

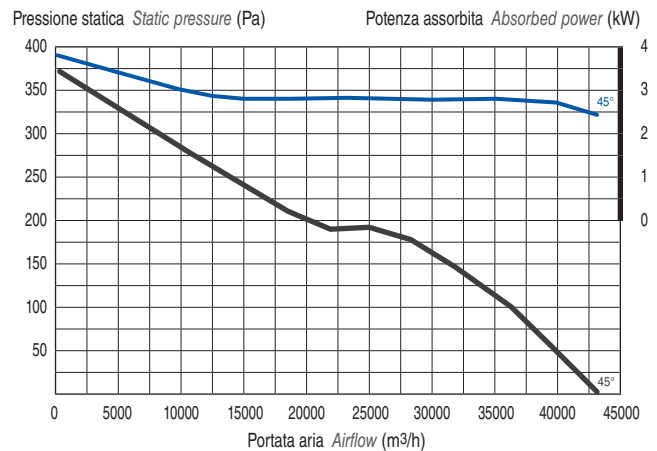

mod. 906/B · 2,2 kW Potenza intallata Motor power

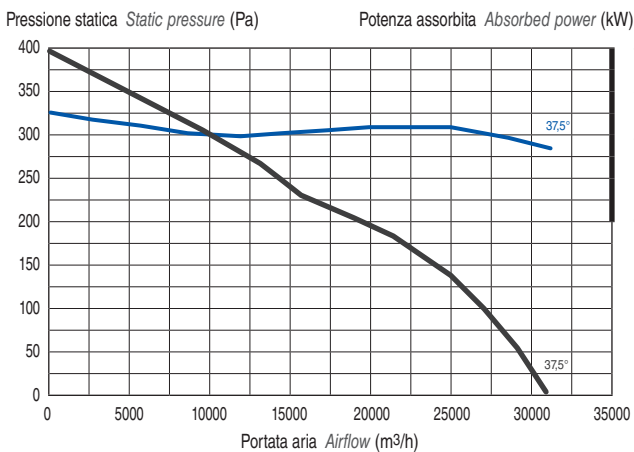

mod. 1006/C · 5,5 kW Potenza intallata Motor power

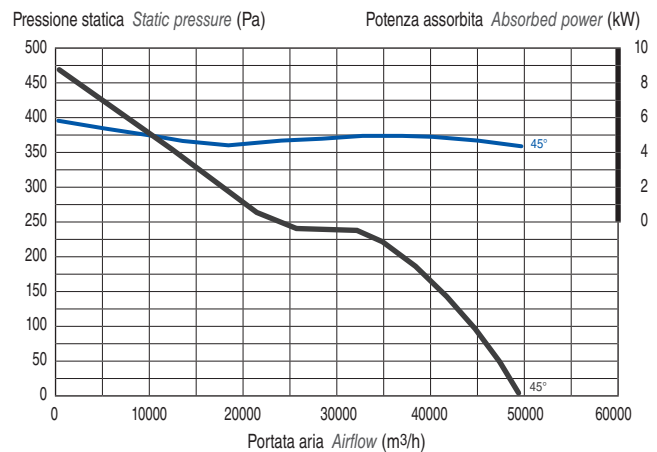

mod. 1126/A · 3 kW Potenza installata Motor power

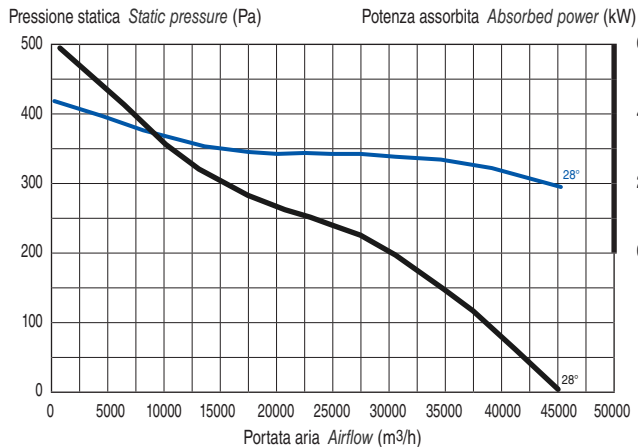

mod. 1256/A · 5,5 kW Potenza installata Motor power

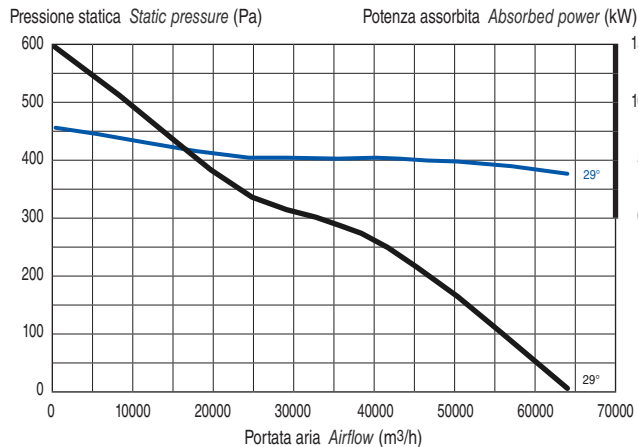

mod. 1126/B · 4 kW Potenza installata Motor power

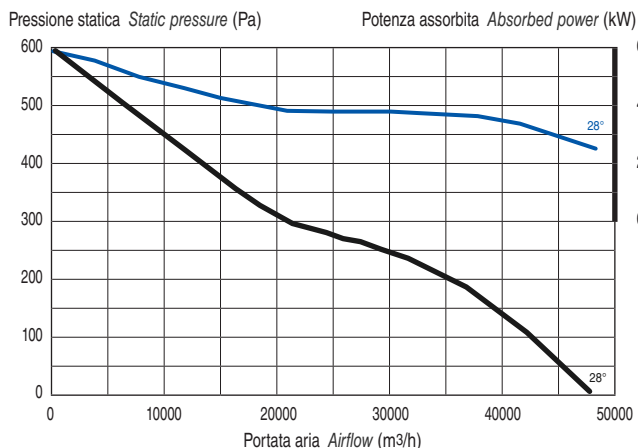

mod. 1256/B · 7,5 kW Potenza installata Motor power

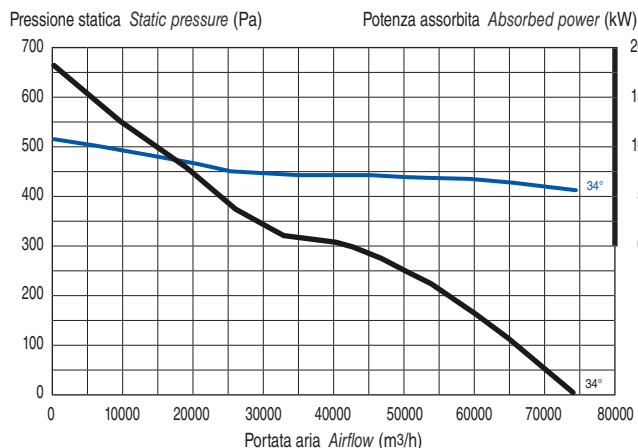

mod. 1126/C · 5,5 kW Potenza installata Motor power

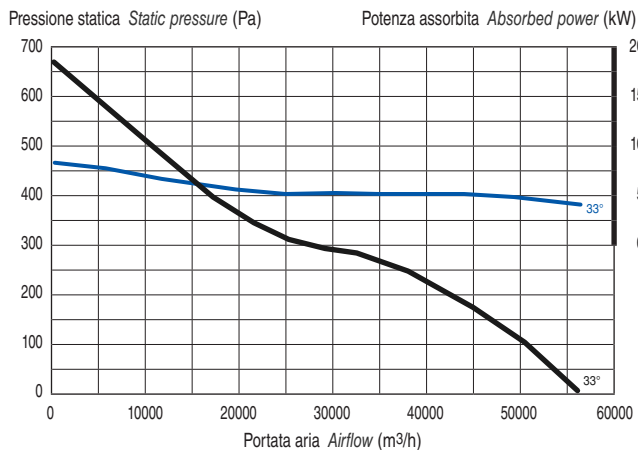

mod. 1256/C · 11 kW Potenza installata Motor power

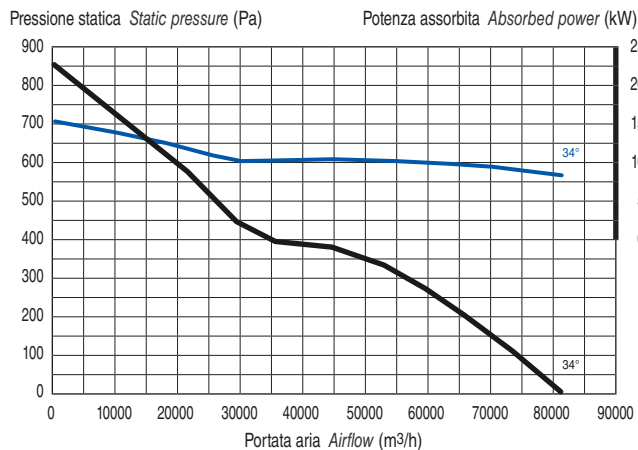

mod. 1406/A · 15 kW Potenza installata Motor power

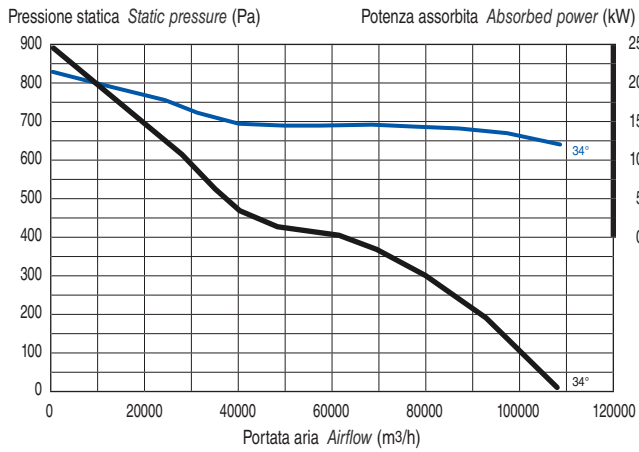

mod. 1406/B · 22kW Potenza installata Motor power

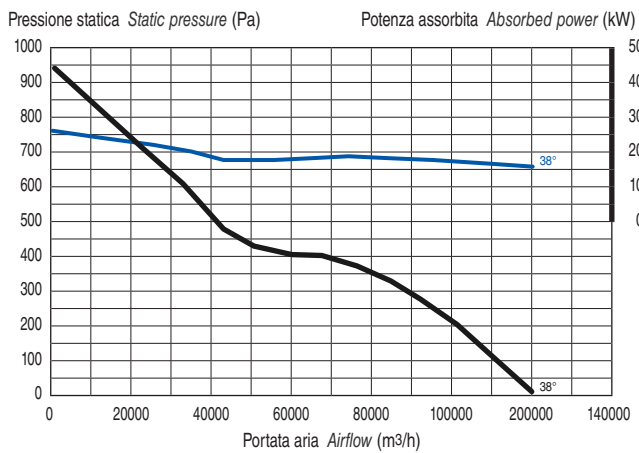

mod. 1406/C · 37 kW Potenza installata Motor power

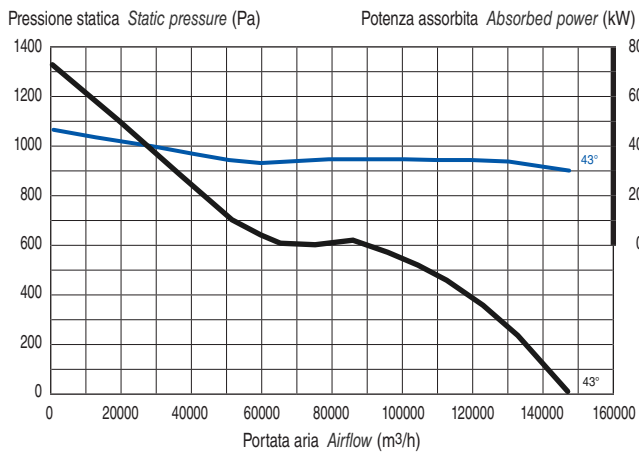

mod. 568/A · 0,18 kW Potenza installata Motor power

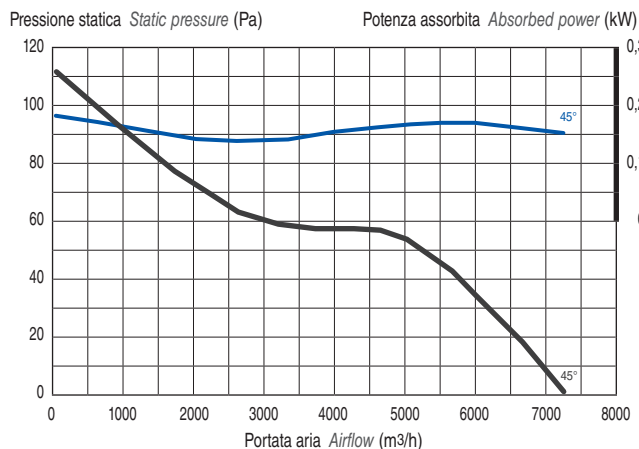

mod. 808/B · 0,75 kW Potenza installata Motor power

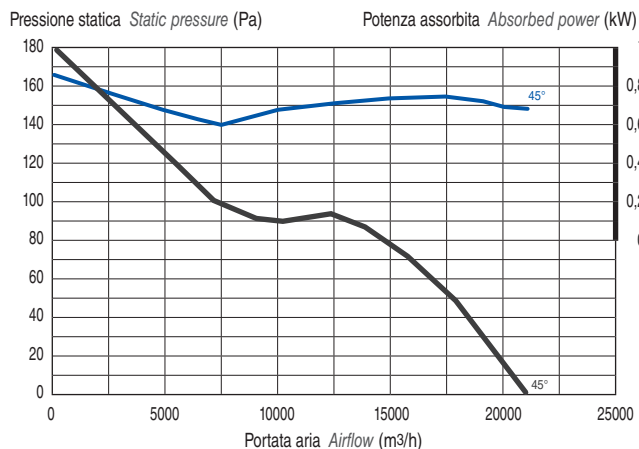

mod. 638/A · 0,18 kW Potenza installata Motor power

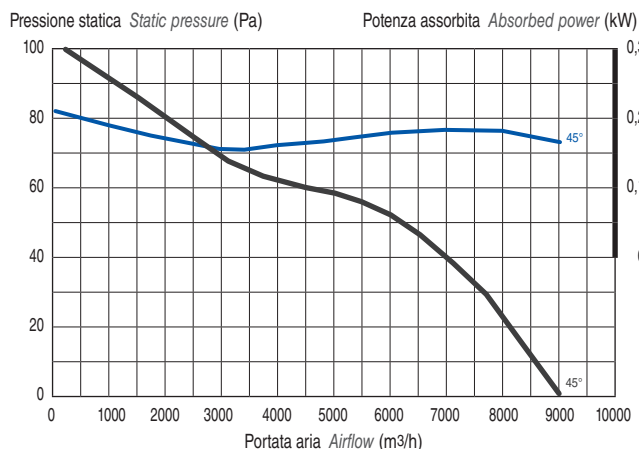

mod. 908/A · 0,75 kW Potenza installata Motor power

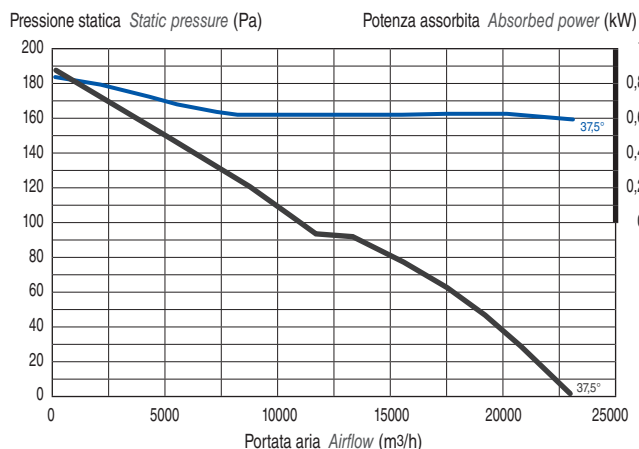

mod. 718/A · 0,37 kW Potenza installata Motor power

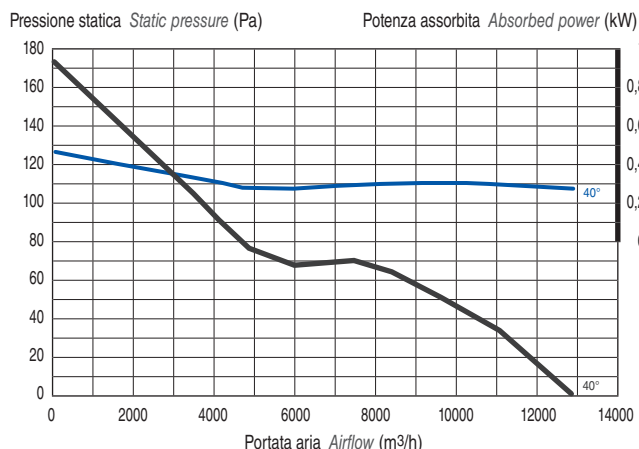

mod. 908/B · 1,1 kW Potenza installata Motor power

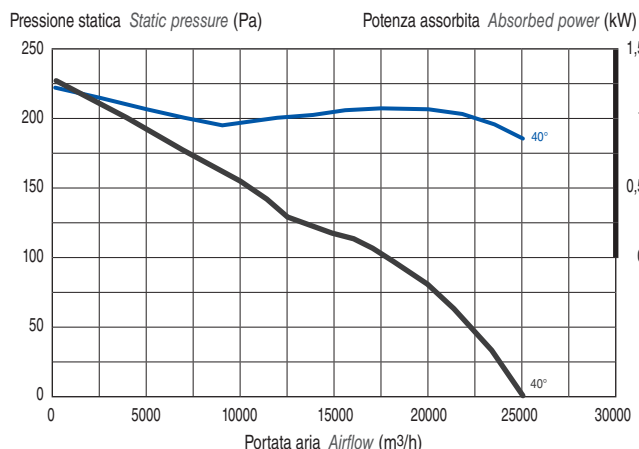

mod. 808/A · 0,55 kW Potenza installata Motor power

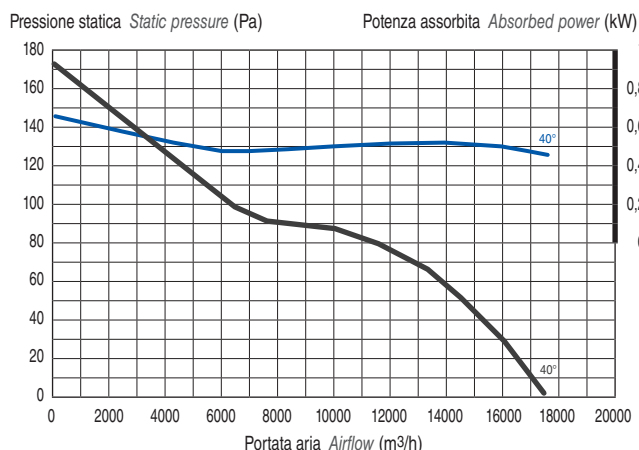

mod. 1008/A · 1,1 kW Potenza installata Motor power

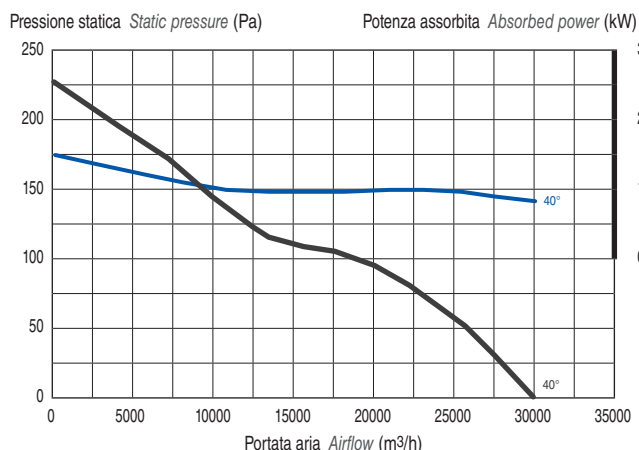

mod. 1008/B · 2,2 kW Potenza installata Motor power

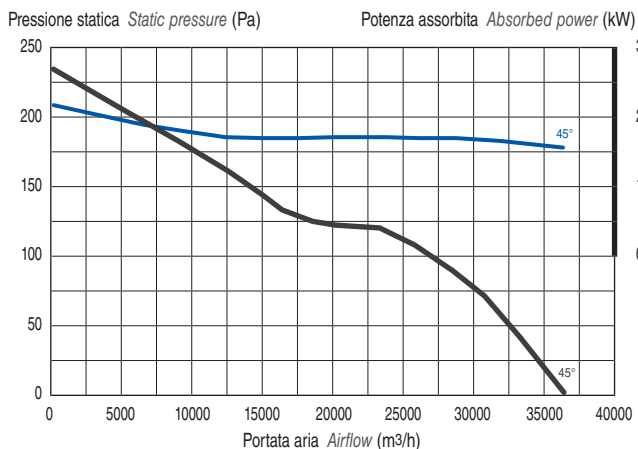

mod. 1258/A · 5,5 kW Potenza installata Motor power

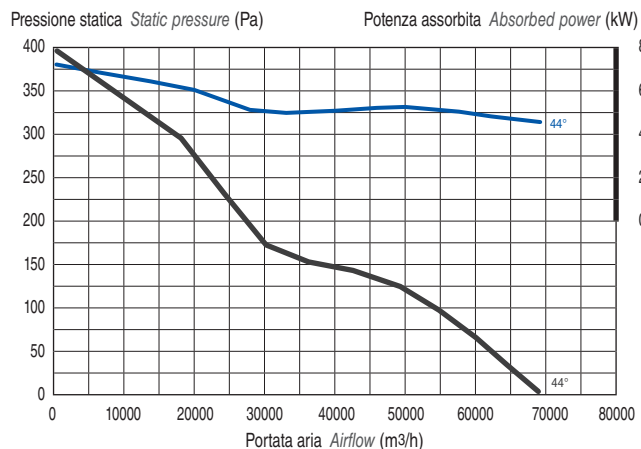

mod. 1128/A · 2,2 kW Potenza installata Motor power

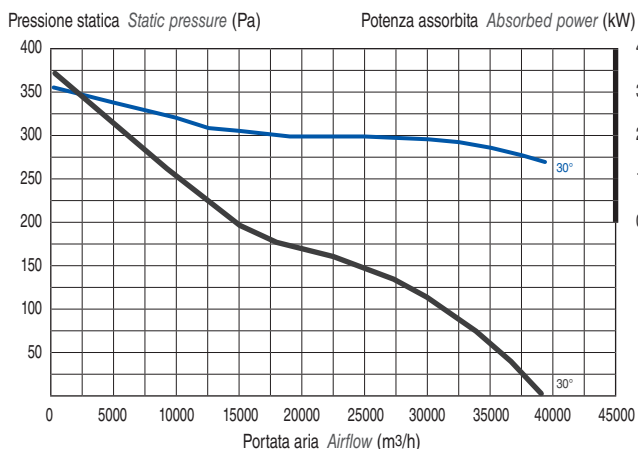

mod. 1408/A · 5,5 kW Potenza installata Motor power

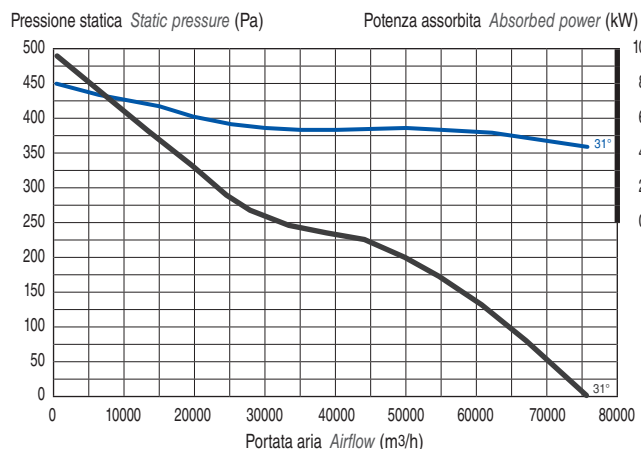

mod. 1128/B · 4 kW Potenza installata Motor power

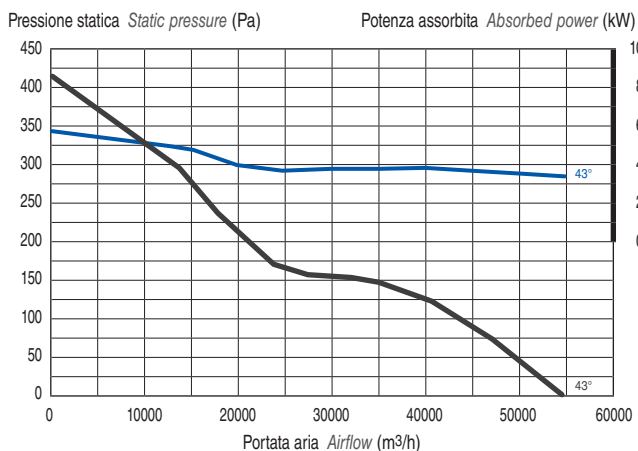

mod. 1408/B · 7,5 kW Potenza installata Motor power

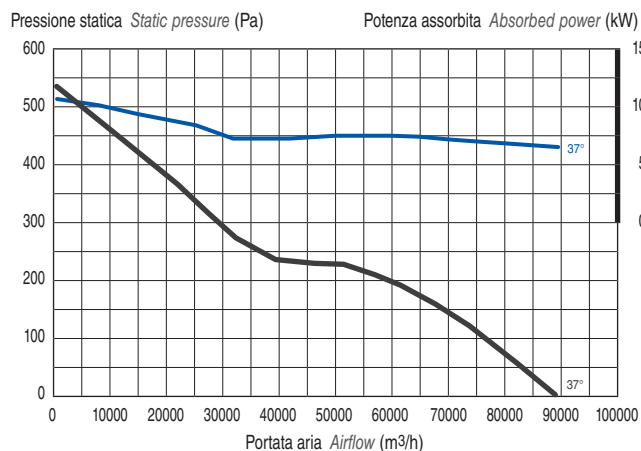

mod. 1258/A · 4 kW Potenza installata Motor power

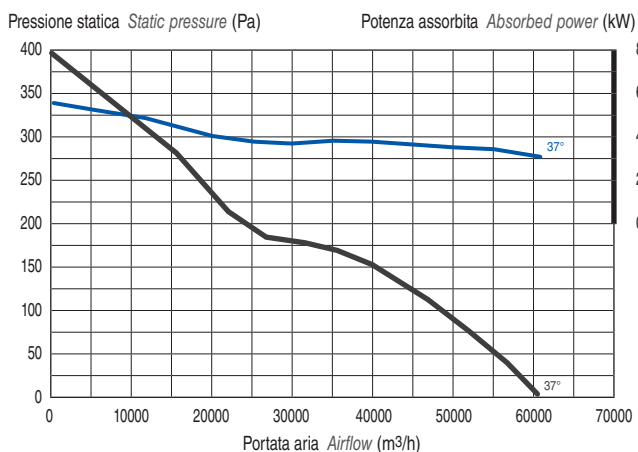

mod. 1408/C · 11 kW Potenza installata Motor power

